



2025

CATALOGO PRODUCTOS



Bienvenido a ProductPlast

¡Con más de 50 años de experiencia en la industria de manufactura de productos plásticos, en ProductPlast nos enorgullecemos de ser líderes en la utilización de material reciclado!

Nuestra Historia

Desde nuestros humildes comienzos, ProductPlast se ha destacado como una empresa pionera en la fabricación de productos plásticos de alta calidad. Durante décadas, hemos trabajado incansablemente para perfeccionar nuestros procesos de producción y mantenernos a la vanguardia de la tecnología.



CUCHARA SOPERA



MATERIAL: POLIPROPILENO

EMPAQUE:

BOLSA X 100 UND – PACA X 5,000 UND

BOLSA X 20 UND – PACA X 5,000 UND

COLOR:

BLANCO

PESO: 2.4 g

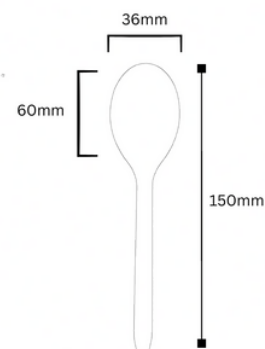

MATERIAL: POLIPROPILENO

EMPAQUE:

BOLSA X 100 UND – PACA X 5,000 UND

BOLSA X 20 UND – PACA X 5,000 UND

COLOR:

BLANCO

PESO: 2.5 g

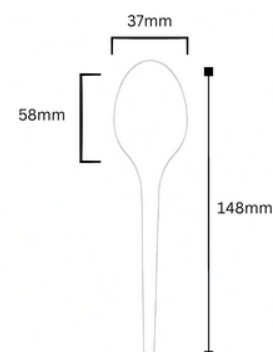

TENEDOR GRANDE



MATERIAL: POLIPROPILENO

EMPAQUE:

BOLSA X 100 UND – PACA X 5,000 UND

BOLSA X 20 UND – PACA X 5,000 UND

COLOR:

BLANCO

PESO: 2.1 g

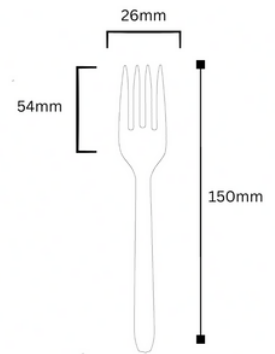

MATERIAL: POLIPROPILENO

EMPAQUE:

BOLSA X 100 UND – PACA X 5,000 UND

BOLSA X 20 UND – PACA X 5,000 UND

COLOR:

BLANCO

PESO: 2.1 g

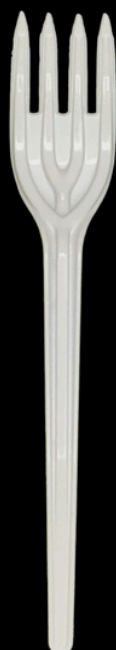
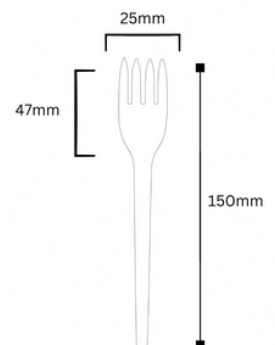

CUCHARA PANDA



MATERIAL: POLIPROPILENO

EMPAQUE:

BOLSA X 100 UND – PACA X 5,000 UND

BOLSA X 20 UND – PACA X 5,000 UND

COLOR:

BLANCO

PESO: 2.5 g

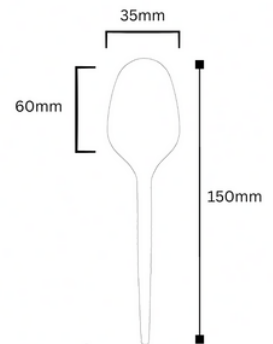

CUCHILLO



MATERIAL: POLIPROPILENO

EMPAQUE:

BOLSA X 100 UND – PACA X 5,000 UND

BOLSA X 20 UND – PACA X 5,000 UND

COLOR:

BLANCO

PESO: 1.8 g

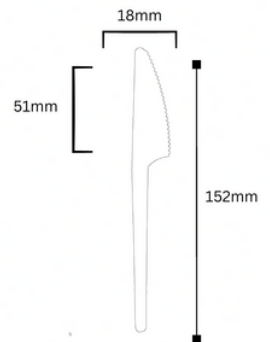

CUCHARA PEQUEÑA



MATERIAL: POLIPROPILENO

EMPAQUE:

BOLSA X 100 UND – PACA X 10,000 UND

BOLSA X 20 UND – PACA X 10,000 UND

COLOR:

BLANCO

PESO: 1.1 g

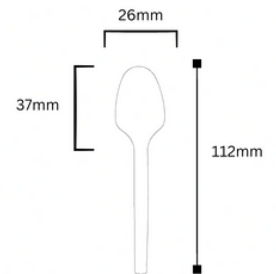

MATERIAL: POLIPROPILENO

EMPAQUE:

BOLSA X 100 UND – PACA X 10,000 UND

BOLSA X 20 UND – PACA X 10,000 UND

COLOR:

BLANCO

PESO: 1.2 g

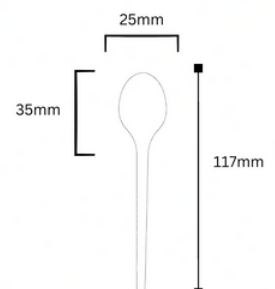

TENEDOR PEQUEÑO



MATERIAL: POLIPROPILENO

EMPAQUE:

BOLSA X 100 UND – PACA X 10,000 UND

BOLSA X 20 UND – PACA X 10,000 UND

COLOR:

BLANCO

PESO: 1.2 g

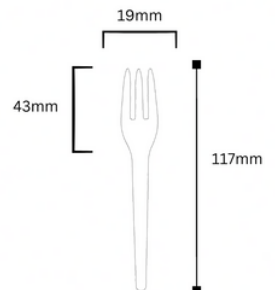

DIMENSIONES PACA

PRODUCTO	ANCHO (CM)	LARGO (CM)	ALTO (CM)	UND
CUCHARA SOPERA	50	75	18	5,000
TENEDOR	50	76	17	5,000
CUCHARA PANDA	55	76	17	5,000
CUCHILLO	40	52	17	5000
CUCHARA PEQUENA	40	60	25	10,000
TENEDOR PEQUENO	40	60	25	10,000



TARRINA 6-8 OZ



TARRINA 6 OZ

MATERIAL: POLIPROPILENO

EMPAQUE:

BOLSA X 25 UND - CAJA X 500 UND

COLOR:

TRANSPARENTE

PESO (TAPA INCLUIDA):

11.2 g

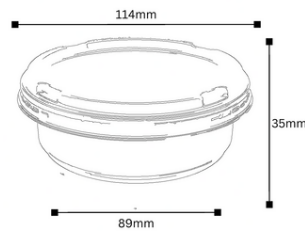

TARRINA 8 OZ

MATERIAL: POLIPROPILENO

EMPAQUE:

BOLSA X 25 UND - CAJA X 500 UND

COLOR:

TRANSPARENTE

PESO (TAPA INCLUIDA):

13.4 g

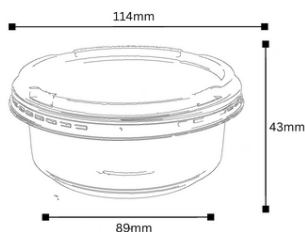

TARRINA 12-14 OZ

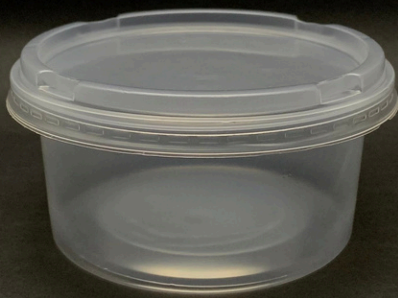

TARRINA 12 OZ



MATERIAL: POLIPROPILENO

EMPAQUE:

BOLSA X 25 UND - CAJA X 500 UND

COLOR:

TRANSPARENTE

PESO (TAPA INCLUIDA):

16.2 g

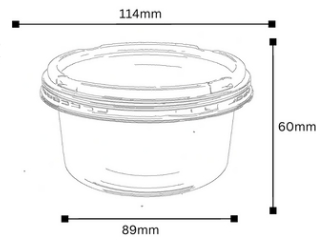

TARRINA 14 OZ



MATERIAL: POLIPROPILENO

EMPAQUE:

BOLSA X 25 UND - CAJA X 500 UND

COLOR:

TRANSPARENTE

PESO (TAPA INCLUIDA):

16.4 g

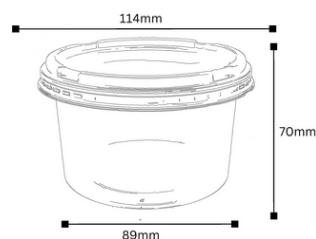

TARRINA 16-24 OZ



TARRINA 16 OZ



MATERIAL: POLIPROPILENO

EMPAQUE:

BOLSA X 25 UND - CAJA X 500 UND

COLOR:

TRANSPARENTE

PESO (TAPA INCLUIDA):

17.3 g

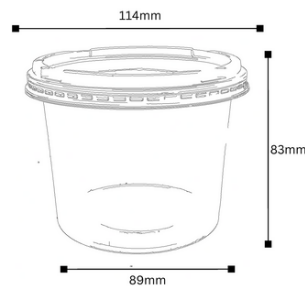

TARRINA 24 OZ



MATERIAL: POLIPROPILENO

EMPAQUE:

BOLSA X 25 UND - CAJA X 500 UND

COLOR:

TRANSPARENTE

PESO (TAPA INCLUIDA):

18.4 g

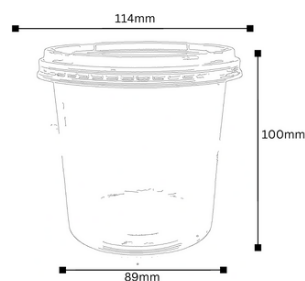

TARRINA 32 OZ



MATERIAL: POLIPROPILENO

EMPAQUE:

BOLSA X 25 UND - CAJA X 500 UND

COLOR:

TRANSPARENTE

PESO (TAPA INCLUIDA):

23.2 g

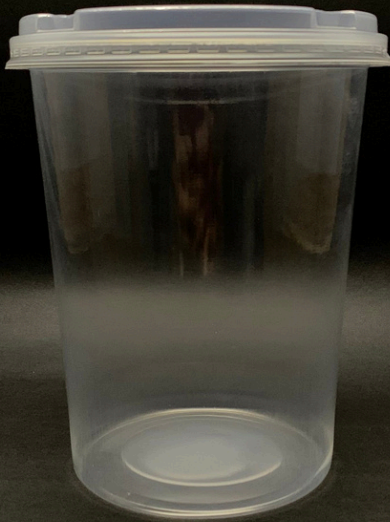
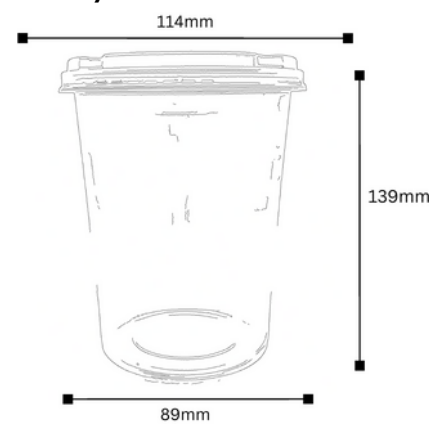

ACCESORIOS TARRINA

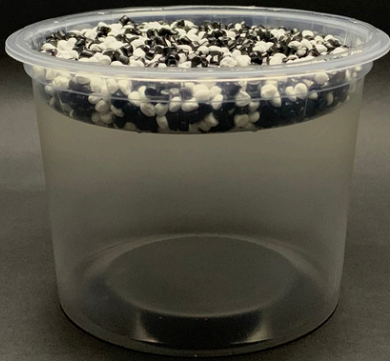

DIVISOR X 1



MATERIAL: POLIPROPILENO

COLOR:
TRANSPARENTE

PESO: 2 g

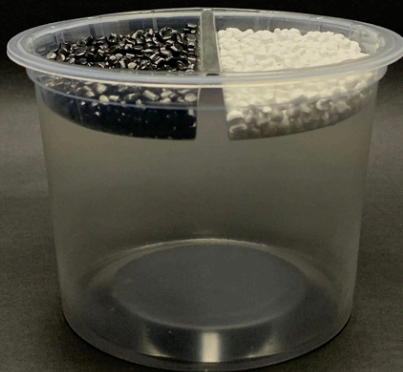
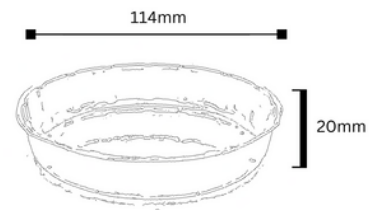

DIVISOR X 2



MATERIAL: POLIPROPILENO

COLOR:
TRANSPARENTE

PESO: 2 g

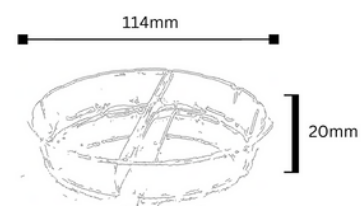

ACCESORIOS TARRINA



TAPA DOMO

MATERIAL: POLIPROPILENO:

COLOR:
TRANSPARENTE

PESO: 2 g

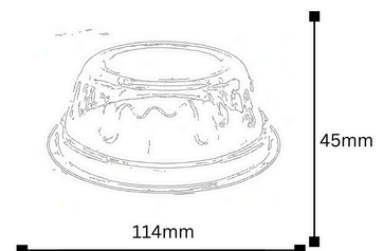

VASOS 13-16 OZ



MATERIAL: POLIPROPILENO

EMPAQUE:

BOLSA X 50 UND - CAJA X 1,200UND

COLOR:

TRANSPARENTE

PESO: 5 g

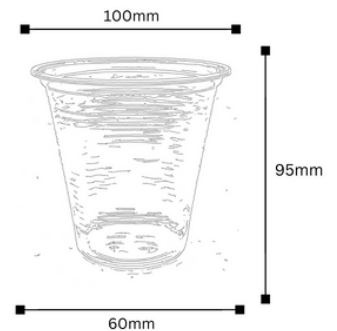

MATERIAL: POLIPROPILENO

EMPAQUE:

BOLSA X 50 UND - CAJA X 1,200 UND

COLOR:

TRANSPARENTE

PESO: 5.5 g

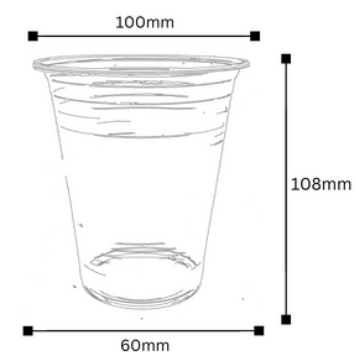

VASOS 7 OZ Y TAPA



MATERIAL: POLIPROPILENO



EMPAQUE:

BOLSA X 50 UND - CAJA X 1,200UND

COLOR:

NEGRO

PESO: 2.4 g

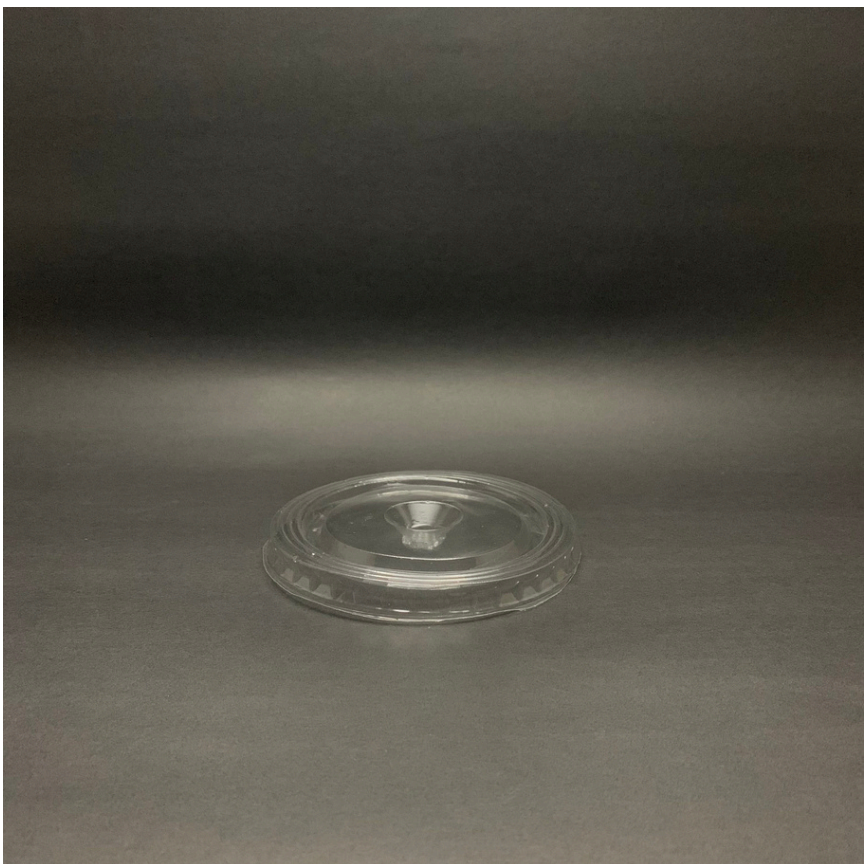
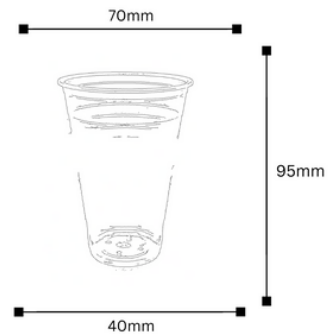

TAPA VASO 13-16 OZ



MATERIAL: POLIPROPILENO

COLOR:

TRANSPARENTE

PESO: 2.4 g

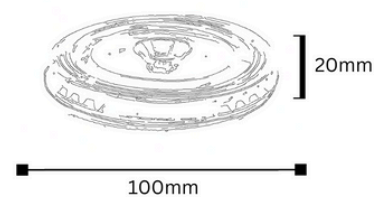

TARRINA LAVALOZA



TARRINA 235



MATERIAL: POLIPROPILENO

COLOR:
BLANCO+COLOR

PESO: 14 g

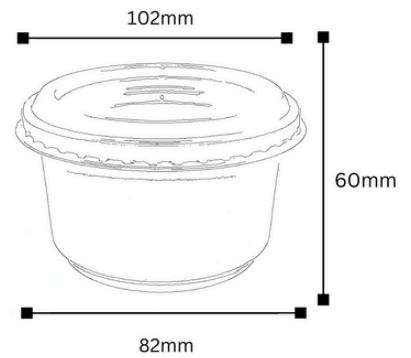

TARRINA 450



MATERIAL: POLIPROPILENO

COLOR:
BLANCO+COLOR

PESO: 25 g

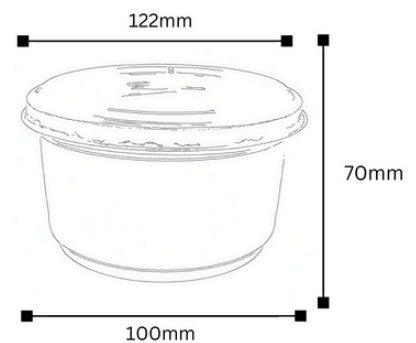

TARRINA LAVALOZA



TARRINA 850



MATERIAL: POLIPROPILENO

COLOR:
BLANCO+COLOR

PESO: 29 g

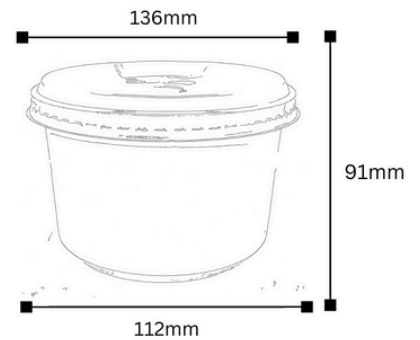

DIMENSIONES CAJA

PRODUCTO	ANCHO (CM)	LARGO (CM)	ALTO (CM)
TARRINAS	47.5	60	47
CAJA VASOS	41	60	40

PATA PARA MUEBLE

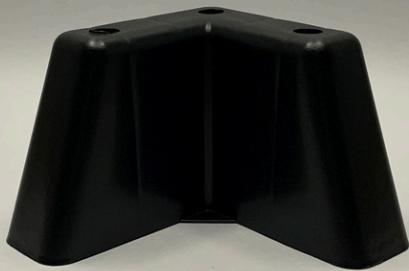

PATA ESCUADRA

MATERIAL: POLIPROPILENO

SOPORE: 300+ KG

COLOR:
NEGRO O COLOR

PESO: 45 g

